

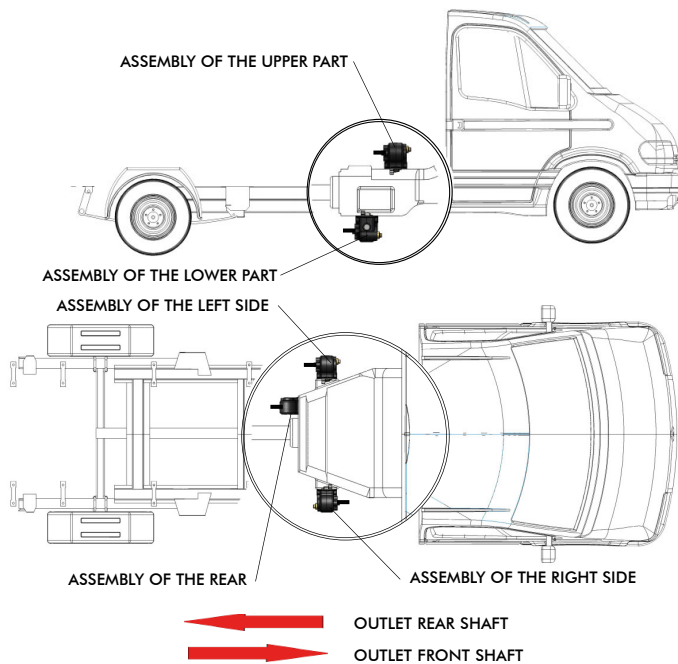

1 - ATTENTION: SAFETY INFORMATION

- The PTOs should be mounted by qualified personnel.
- Use suitable tools and measurement instruments.
- Use personal protections and precautions set out by the current regulation on safety in the workplace.
- Avoid assembling or disassembling the PTOs on your own.
- Ensure the system or the PTO cannot involuntarily started up.
- Do not assemble the PTO or parts of the PTO or conduct maintenance work when the engine is on.
- Ensure all the components have been assembled properly and the level of oil in the gear box has been topped up before starting up the vehicle: incorrect assembly of the PTO may cause the PTO and/or the gearbox to break and damage other parts of the vehicle.
- The splined shaft (male or female) protruding from the PTO rotates with no protection when the pump has not been assembled. Avoid any contact between the shaft and any object and, more importantly, protect the working area to prevent contact with body parts or clothing.
- Install the pump or the cardan shaft only when the engine is off and the PTO has been disconnected.
- For the assembly of the cardan shaft, it is necessary to use all the precautions and protections set out by the current regulation on safety in the workplace.
- The gearbox or the PTO may attain high very temperatures after prolonged use of the vehicle or the PTO. It is therefore necessary to take all the necessary measure to prevent burns or wait for the mechanical parts to cool down to temperatures appropriate for skin contact.
- Some PTOs are considerably heavy and to assemble and disassemble them it is necessary to use adequate lifting or resting systems to prevent crushing hazards.
- Any waste oil or that has not been used should not be discarded in the environment, but should be processed according to the directives included in current regulation on the disposal of special waste.
- All metal or rubber parts discarded during assembly or disassembly of the PTOs should be disposed of in compliance with current regulation on the disposal of special waste.

2 - INDICATIVE ASSEMBLY POSITIONS OF THE PTOs



RULES APPLYING TO THE DIRECTION OF ROTATION OF THE PTO OUTPUT SHAFT

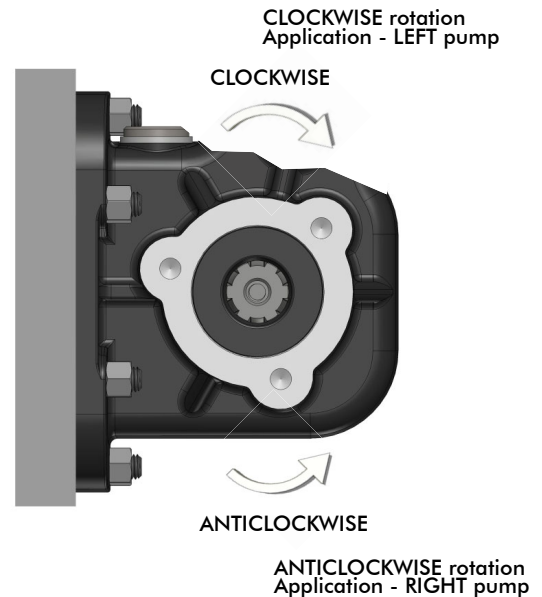

Data: Mercoledì 15 ottobre 2014

MOST COMMON PTO SHAFT OUTLET VERSION

Codice foglio: 997-001-00011 Rev. AB

VERSION 13

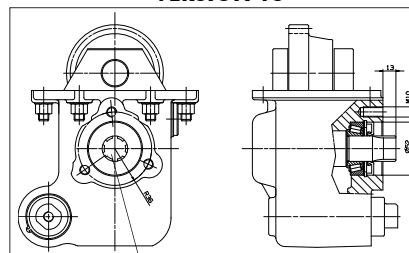

Male shaft 6x21x25 (ISO14)
Rear outlet

VERSION 14

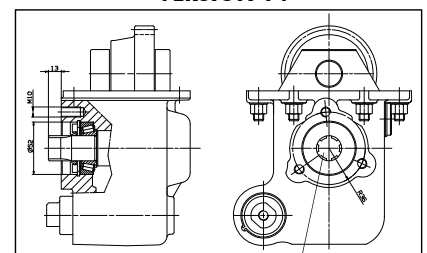

Male shaft 6x21x25 (ISO14)
Front outlet

VERSION 15

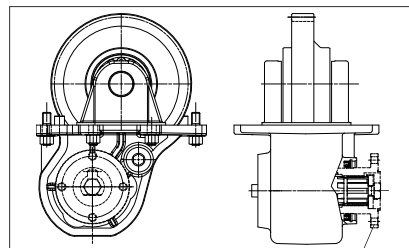

Male shaft 8x32x36 (ISO14) Rear outlet
This version always requires the flange (114...)

VERSION 17

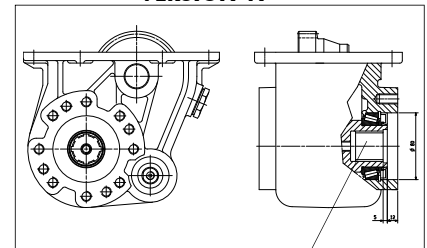

Female hub 8x32x36 (ISO14)
Rear outlet

3 - GENERAL INFORMATION TO MOUNT POWER TAKE-OFFS

- Carefully follow these general assembly indications, both as far as the safety precautions and the assembly stages of the PTOs are concerned.
- The general indications do not replace specific instructions contained in the PTOs, in the assembly kit or in the various assembly accessories (adapters, auxiliary shafts, etc).
- It is necessary to also follow any instructions related to the vehicle's gearbox.
- Install the PTO's with the vehicle placed on a flat surface, so that oil levels in the gearbox can be checked correctly.
- Only use the components contained in the PTO packaging and related accessories (assembly kit, auxiliary shafts, adapters).
- Only use gaskets supplied.
- Do not use sealing paste, unless explicitly indicated in the specific instructions.
- It is advisable to use a medium-strength threadlocker to tighten the studs and screws.
- Before assembling the PTO, check that the vehicles clutch and transmission work correctly and that the gearbox does not produce any anomalous noises or issues in inserting some gears.

TIGHTENING TORQUE					
Thread diameter - Screw (mm)	M8	M10	M12	UNC 3/8	UNC 7/16
Screws and nuts torque (Nm)	25	50	80	25	60
Studs torque (Nm)	10	20	30	10	20

TABLE 3



For aluminium gearboxes the tightening torque needs to be reduced by 30%. Note on the tightening torque: the tightening torques reported are only means as a guide and do not replace the indications given by the vehicle's manufacturer of the gearbox manufacturer.

4 - INSTALLATION OF SIDE MOUNT PTOs

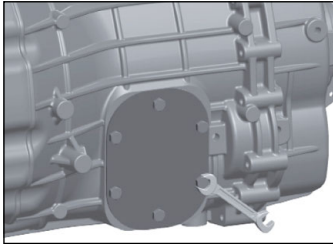

4.1 - Unscrew the emptying plug and remove the oil from the gearbox. Screw the emptying plug back with the tightening torque indicated in the gearbox's operating manual.

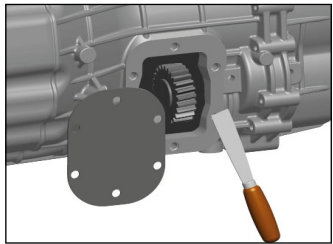

4.2 - Identify the suitable gearbox opening to mount the PTO and remove the cover with the related gasket.

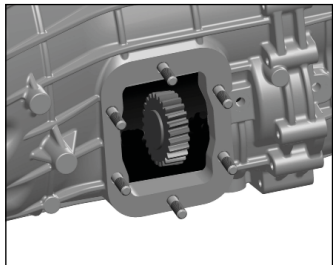

4.3 - Check that the gearing is compatible with the PTO's gearing in terms of position, inclination of the tooth and teeth size. This needs to be carried out as an additional check that the right PTO has been selected for the specified gearbox.

4.4 - Clean the surface of the opening, make sure no foreign matter is introduced in the gearbox.

4.5 - If the PTO needs to be mounted with studs, insert them (with the short thread side) in the related threaded holes of the gearbox, using a medium-strength threadlocker (LOCTITE 243, LOXEAL 55-03 or similar). Tighten the studs using a torque like the one indicated in TABLE 3 Chap.3. If the gearbox has feed-through threaded holes, the threadlocker should also have a sealing action and it is necessary to check that the studs do not interfere with the gearing of with parts inside the gearbox.

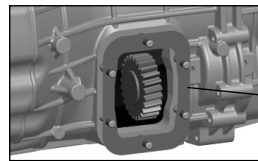

4.6 - Position the sealing gasket.

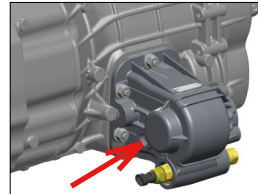

4.7 - Install the PTO and tighten the nuts with lower torque compared to the definitive one.

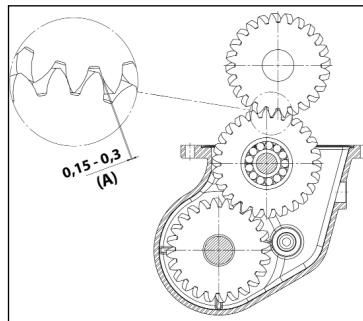

4.8 - Check, through the inspection hole (indicated by the arrow) the clearance between the gearings. The clearance should be between 0.15 and 0.3 mm (A). The clearance is controlled manually and therefore it cannot be precise. This is why it is necessary to proceed by attempts until the optimal clearance is achieved.

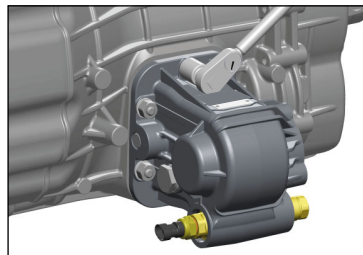

4.9 - Once the optimal clearance has been defined, it is necessary to tighten the nuts or the screws of the PTO fully home with the tightening torque shown in TABLE 3 Chap.3.

4.10 - Top up the oil in the gearbox bearing in mind that usually a side mount PTO uses up approximately 0.5-0.8 litres of oil. Install the control system. Start up the vehicle and engage the PTO. Conduct the checks as illustrated in the paragraphs below.

5 - INSTALLATION OF THE REAR PTOs

The installation of the rear PTOs is conducted according to the type of PTO and the accessories to install. It is necessary to check and follow the specific instructions contained in the adapters and the auxiliary shafts. The indications below are meant as a guide.

- 5.1 - Empty the oil of the gearbox (for some gearboxes there is no need to empty the oil as the level does not reach the rear door - check the gear box's operating manual).
- 5.2 - Identify the rear opening and remove its cover and gasket. The gasket removed should not be used to assemble the PTO.
- 5.3 - Clean the surface of the door, make sure no foreign matter is introduced in the gearbox
- 5.4 - If necessary, install the auxiliary shaft and/or adapters following the specific instructions with special care for cases where it is necessary to adjust the bearings with cone-shaped rollers.
- 5.5 - If the PTO needs to be assembled with studs, insert them (con the short thread side) in the related threaded holes using a medium-strength threadlocker (LOCTITE 243, LOXEAL 55-03 or similar). Tighten the studs using a torque like the one indicated in TABLE 3 Chap.3. If the gearbox has feed-through threaded holes, the threadlocker should also have a sealing action.
- 5.6 - Install the PTO on the gearbox and tighten the nuts or screws (also in case of screws make use of a medium-strength threadlocker) with the tightening torque indicated in the table.

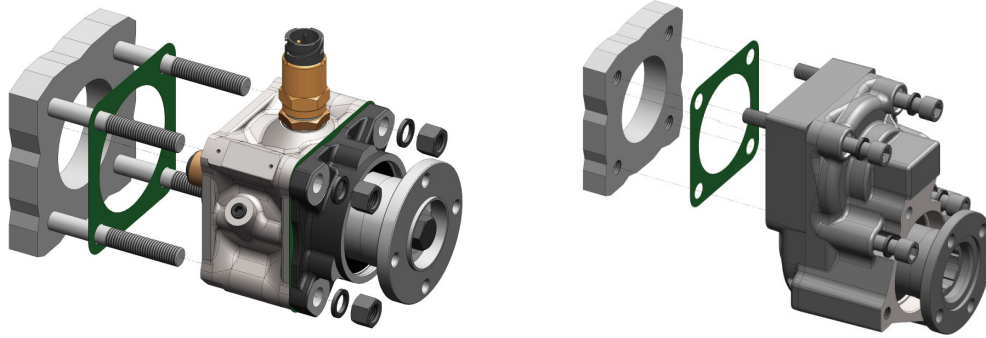

IF THE PTO HAS NO OIL SEAL, IT IS NECESSARY TO MOUNT THE PUMP BEFORE EXECUTING THE LISTED CONTROLS

5.7 - Top up the oil in the gearbox bearing in mind the higher demand of oil due to the presence of the PTO.

5.8 - Install the fitting and the air coupling pipe.

For rear PTO with 2 wheel it is recommended, to optimise the lubrication of internal parts, to comply with the assembly positions indicated.

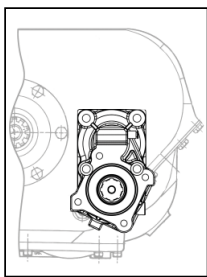

PTO Vertical ASSEMBLY
-Low outlet

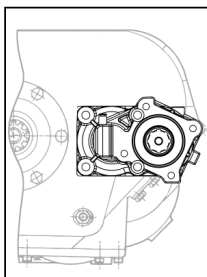

PTO Horizontal ASSEMBLY

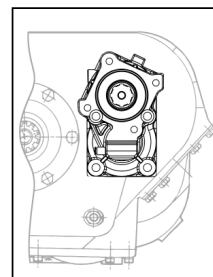

PTO Vertical ASSEMBLY
-High outlet



6 - PREPARATION OF THE REAR PTOs - 012 RANGE

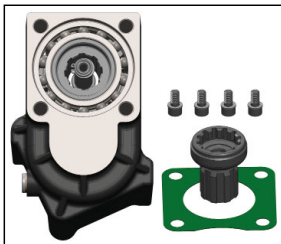

The PTOs part of the 012 range feature an engaging coupling separated from the PTO and which changes according to the gearboxes where it needs to be installed. The coupling comes with the 097042xxxx adapters.

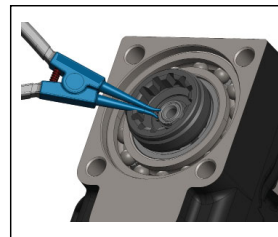

6.3 - Use the designated pliers to reposition the circlip in the seat of the pin, checking that this is perfectly inserted. **Attention: DO NOT EXPAND THE CIRCLIP MORE THAN IT NEEDS TO BE TO AVOID PERMANENT WARPING**

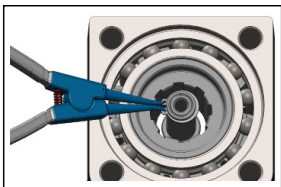

6.1 - Use the designated pliers to remove the circlip from the seat of the central pin. **Attention: DO NOT EXPAND THE CIRCLIP MORE THAN IT NEEDS TO BE TO AVOID PERMANENT WARPING.**

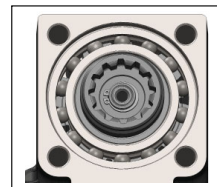

ATTENTION: incorrect positioning of the circlip or warping of the circlip during assembly may cause the PTO to fail to disengage.

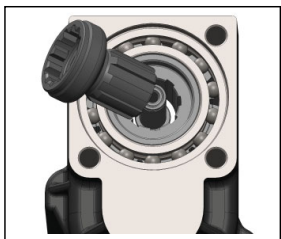

6.2 - Insert the coupling in the seat of the PTO

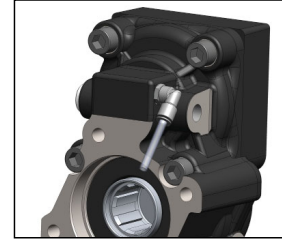

6.4 - Proceed to install the PTO, as illustrated in the previous paragraph.



7 - CHECKS

7.1 - Checking the coupling

Connect and disconnect the PTO a few times (follow the paragraph HOW TO USE THE PTO) to check the coupling system is working properly. Any anomalous noise produced during coupling is only due to the fact that the PTO's gears are not completely still and therefore to the fact that the vehicle's clutch is not working properly. Either the clutch pedal has not been fully pressed or one has not waited the time necessary for the gearbox's gears to stop.

7.2 - Checking noise levels for lateral PTOs

- If the PTO does not produce anomalous noises or noises that are not that different from those of the clutch, this means that the assembly and the teeth clearance are correct;
- If the PTO produces a screeching noise (whistle) this means that the PTO has been assembled with insufficient clearance between the teeth. In this case it is necessary to disassemble the PTO and add a gasket between the surface of the PTO and that of the gear box;
- If the PTO produces a beating, this means that the PTO has been assembled with excessive clearance between the teeth. In this case it is necessary to disassemble the PTO and remove a gasket or use a thinner gasket.

For the purposes of the durability of the PTO it is generally preferable to have a slightly higher clearance between the teeth rather than a low one.

7.3 - Leak check

After it has been operating for a few minutes, stop the vehicle and check there are no oil leaks from the surface connecting the gearbox to the PTO or from other parts of the PTO.

7.4 - Clamping check

After a few minutes of operation, check that the threaded parts have been tightened. Checks related to noise levels, leaks and clamping should also be conducted when the vehicle is hot.

8 - PTO FOR DIRECT ASSEMBLY ON THE PUMP

To prevent splines from wear please grease pump shafts and / or couplings.

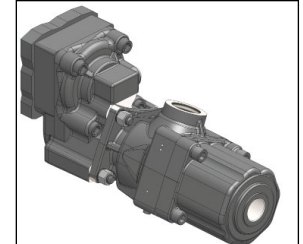
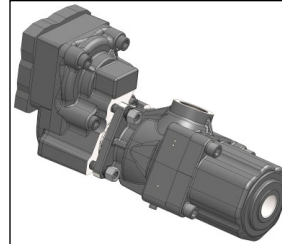
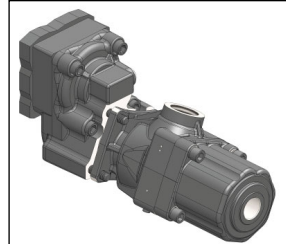
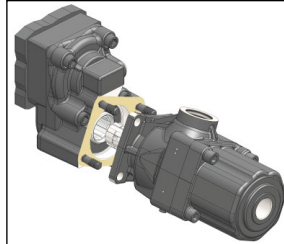
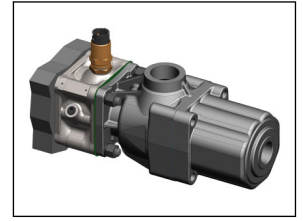
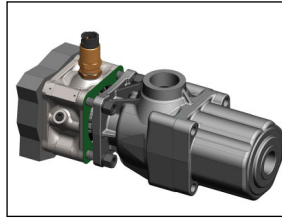
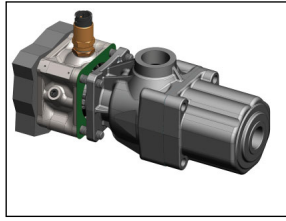
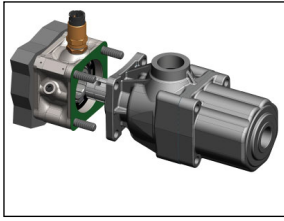

1 - Install the pump on the PTO with the sealing gasket if supplied with the assembly kit.

2 - Move the pump away from the PTO by 10mm.

3 - Screw the nuts a few mm.

4 - Push the pump against the PTO and tighten the nuts fully home. The tightening torque shown in **TABLE 3 Chap.3**.

ISO PUMPS ON ISO PTO'S WITHOUT BEARING MOUNTING

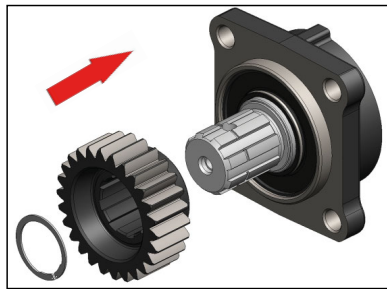

1 - Mount loose gear and circlip on the pump's shaft.

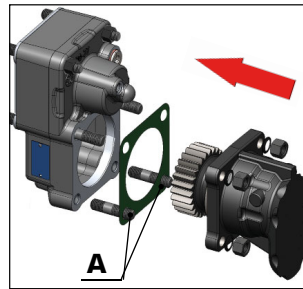

2 - After mounting the PTO on the gearbox, screw the studs (pos.A) onto the PTO. Place the intermediate gasket and then fit the group (fig.1) onto the PTO. Fix the pump applying the tightening torque indicated in the **TABLE 3 Chap.3**.

9 - HOW TO USE THE PTO

The procedure applies to PTOs installed on **NON-automatic gearboxes**.

For PTOs installed on automatic gearboxes, please refer to the related instructions.

PTO engagement procedure must be always carried with vehicle stationary and parking brake applied.

9.1 CONNECTING THE PTO



- Press the clutch pedal and keep it pressed for a few seconds to stop the gears from turning.
- Activate the PTO control.
- The PTO engages (the actual coupling is confirmed when the related PTO CONNECTION indicator, if any, turns on).
- SLOWLY release the clutch pedal.

9.2 DISCONNECTING THE PTO



- Press the clutch pedal and keep it pressed for a few seconds.
- Bring the PTO control back to the off position.
- The PTO disengages (the actual coupling is confirmed when the related PTO CONNECTION indicator, if any, turns off).
- Release the clutch pedal.

ATTENTION: incorrect connection or disconnection causes premature damaging to the internal organs of the PTO. Therefore CAREFULLY follow the indicated instructions.



WARNING: WHEN THE VEHICLE IS ON THE MOVE THE PTO MUST BE ALWAYS OFF.

10 - MAINTENANCE

In order to get a longer PTO life, it is necessary to execute regularly the following controls:

- **LEAKAGE** : make sure there is no leakage from the surface connecting the gearbox to the PTO or from any other parts of the PTO itself. Check the gearbox oil level.
- **TIGHTENING**: verify that the tightening of the bolts/nuts/screws is correct and, eventually, set it at the recommended value (see TABLE 3).
- **SHAFT GREASING** : in order to prevent early wearing, it is recommended to grease the shaft at each maintenance operation.

The frequency of the maintenance services depends by the way the PTO is used.

The first check-up should be performed after 10 days from the installation, then every 40 to 50 days.

The company reserves the right to make any modification to improve the content of this publication with no obligation to communicate such update.
It is forbidden to reproduce texts and diagrams or part of them without written authorization.